

No. 724,983.

PATENTED APR. 7, 1903.

P. E. WIRT.
FOUNTAIN PEN.

APPLICATION FILED JAN. 12, 1903.

NO. MODEL.

2 SHEETS—SHEET 1.

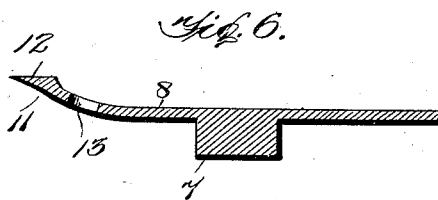
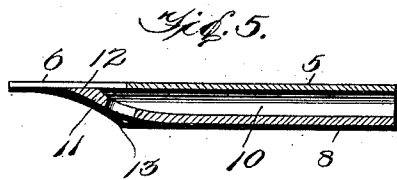
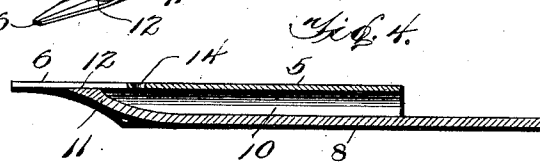
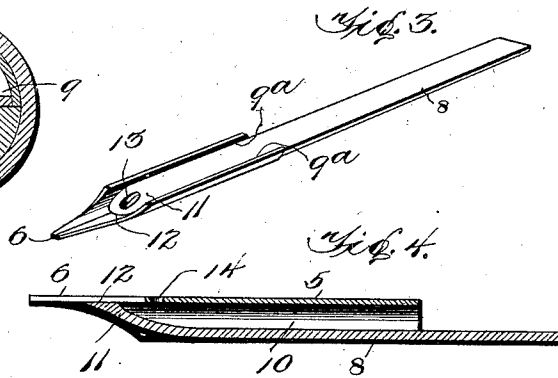
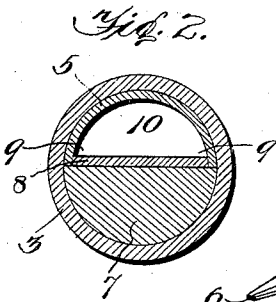
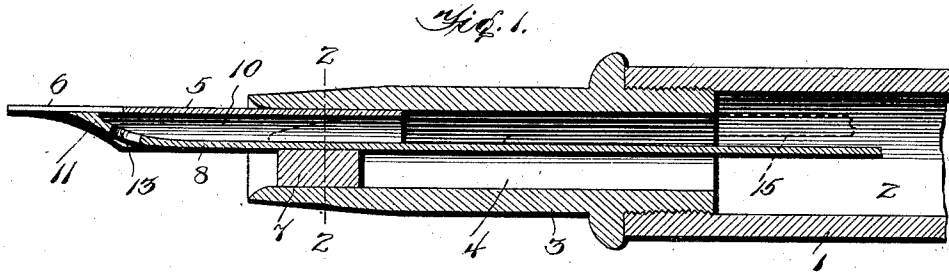

Inventor
Paul E. Wirt

Witnesses

J. L. Maclean
S. S. Ray

By

S. P. Kolhaupfer

Attorney.

No. 724,983.

PATENTED APR. 7, 1903.

P. E. WIRT.
FOUNTAIN PEN.

APPLICATION FILED JAN. 12, 1903.

NO MODEL.

2 SHEETS—SHEET 2.

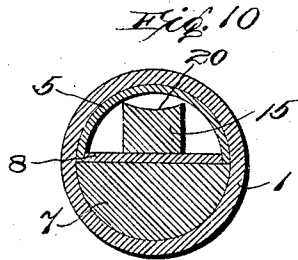
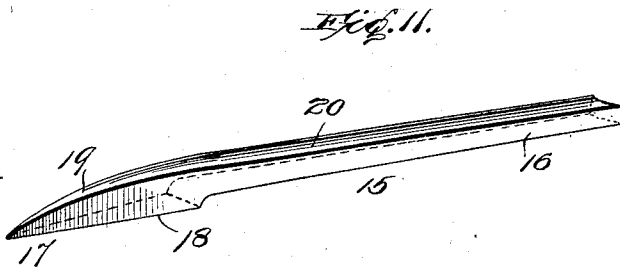
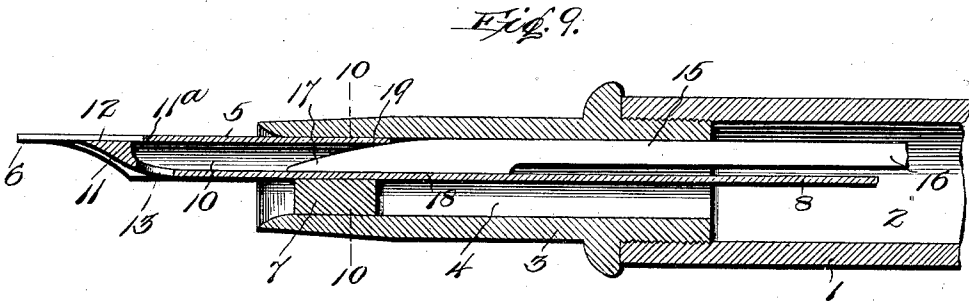
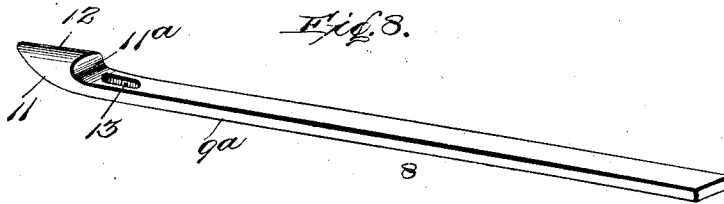
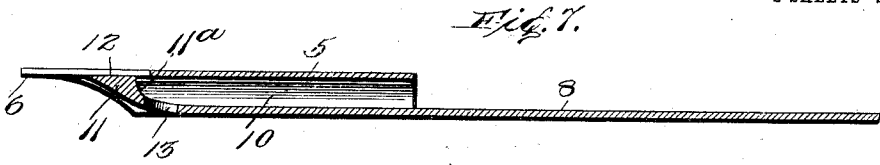

Witnesses
J. L. Moorman
A. S. Ray

Inventor
Paul E. Wirt.

by *A. S. Moorman*
 Attorney

UNITED STATES PATENT OFFICE.

PAUL E. WIRT, OF BLOOMSBURG, PENNSYLVANIA.

FOUNTAIN-PEN.

SPECIFICATION forming part of Letters Patent No. 724,983, dated April 7, 1903.

Application filed January 12, 1903. Serial No. 138,725. (No model.)

To all whom it may concern:

Be it known that I, PAUL E. WIRT, a citizen of the United States, residing at Bloomsburg, in the county of Columbia and State of Pennsylvania, have invented certain new and useful Improvements in Fountain-Pens, of which the following is a specification.

This invention relates to fountain-pens, and particularly to an improvement in the feeding means thereof.

The main object, therefore, of the invention is to associate with the pen-point and the reservoir of a fountain-pen a practical type of feeder of great simplicity and ease of adjustment, while at the same time producing a means for attracting the ink downward to the nibs whereby a most desirable and reliable flow of ink is provided for, and yet obviating the flooding or skipping common to many of the fountain-pens on the market.

It is well known to those familiar with the art that it is very important to have the ink-supply at the nibs or pen-point suspended in such a manner that it will flow easily from the pen with as little skipping as possible. In the average type of fountain-pens it very often occurs that even though there may be an apparent and plentiful supply of ink at and about the end of the feeder the same does not readily leave the point of the pen and have an even smooth flow by reason of the atmospheric pressure upon the column of ink within the reservoir. In other words, the construction of the feeder at the nibs, its size, adjustment, or other structural details may be such that oftentimes the ink is prevented from running off onto the paper on account of a slight back pressure produced by the atmosphere seeking to replace withdrawn ink within the reservoir. This difficulty is commonly met with in the manufacture and use of many fountain-pens, and the improvement contemplated by the present invention is intended to provide a novel construction and arrangement of parts which will effectually counteract the back-pressure tendency referred to, thus insuring a more ready working of the pen.

A further object of the invention is to so dispose or arrange the means or vent for admitting air as to best secure the objects to be attained.

With these and many other objects in view, which will more readily appear as the nature of the invention is better understood, the same consists of the construction, combination, and arrangement of parts, which will be hereinafter more fully described, illustrated, and claimed.

The essential feature of the invention involved in the novel arrangement of the feeder or feed-bar with reference to the pen-point is susceptible to some modification; but the preferred embodiments of the invention are shown in the accompanying drawings, in which—

Figure 1 is a sectional view of the feeding end of a fountain-pen, showing the improved feeding means associated with the pen-point and the reservoir. Fig. 2 is a cross-sectional view on the line 2 2 of Fig. 1. Fig. 3 is an inverted perspective view of the pen-point and the feeder or feed-bar arranged in operative relation thereto. Fig. 4 is a detail sectional view showing a modification in which the air-vent is provided in the pen-point and the feed-bar left entirely imperforate. Fig. 5 is another modification showing that a short-length feed-bar may be employed with practical results. Fig. 6 is a detail modification of the feed-bar, suggesting the expedient of forming the holding-plug integral therewith instead of separate therefrom. Figs. 7 and 8 are detail sectional and perspective views, respectively, showing a modified form of the terminal distributing-foot at the outer or lower end of the feed-bar. Fig. 9 is a sectional view of the feeding end of the pen, showing in full lines the adjustable flow-regulator associated with the feeder and pen-point. Fig. 10 is a cross-section on the line 10 10 of Fig. 9. Fig. 11 is a detail in perspective of the flow-regulator.

Like reference-numerals designate corresponding parts throughout the separate figures of the drawings.

The improvement contemplated by the present invention is applicable to all types of fountain-pens, particularly of the underfeed type, and which are of such formation as to permit of the employment of a feeder, feed-bar, feed-tongue, or feed-shaft, presenting a substantially flat surface next to the pen-point to permit of the formation of capillary

channels or grooves in the manner provided for by the invention.

The improvement claimed is exemplified by the several figures of the drawings, and referring thereto the numeral 1 designates a tubular holder of the ordinary form, which provides the interior reservoir 2 of required capacity for holding a supply of ink. The holder 1 carries at its lower or feeding-out end a pen-bearing section or nozzle 3 of some form; but for illustrative purposes this pen-bearing section is shown as of the detachable type and having the usual bore or passageway 4 in direct communication with the reservoir 2 and constituting the lower part of such reservoir. Irrespective of the construction of the pen-bearing section or nozzle and the manner of connecting the same with the reservoir-holder the said element receives in the outer or lower end thereof the pen-point 5, having the usual nib portion 6, designed to be detachably held in position by the holding-plug 7 of segmental or semicylindrical form and lying between the inner wall of the pen-bearing section 4 and the outer side of the feeder 8. The holding-plug 7 not only acts in the capacity of a retaining means for the pen-point, but also serves to lock the feeder in place in operative relation to the pen-point. There is an inner frictional wedging action of the plug 7 within the mouth of the pen-bearing section or nozzle 4 to firmly fasten the cooperating elements in position, while at the same time permitting of the easy removal thereof for purposes of repair or adjustment. The said plug 7 is illustrated in Figs. 1 and 2 as consisting of a separate piece or body; but it will of course be understood that in the carrying out of the invention the same could be formed integral with the pen-bearing section or nozzle or integral with the feeder itself, as suggested in Fig. 6 of the drawings, without departing from the spirit of the invention or affecting the use of said plug in holding the parts in assembled relation.

The essential feature of the invention resides in the special operative relation which the feeder 8 bears to the pen-point 5. This provides a most desirable and reliable flow of the ink and for the withdrawal of the ink as nearly as possible at about the same point as the air is admitted for the usual purpose.

Referring particularly to the construction and arrangement of the feeder 8, it is to be observed, in the first place, that the said feeder is of very simple formation and readily separable from and fitted to the point of the pen. Preferably this feeder consists of a comparatively narrow flat feed bar or shaft of the usual material and of any desired length best suited for the particular pen with which it may be associated. The invention may be carried out by employing a feed bar or shaft of a short length and not extending outside of the plane of the pen-point, as suggested by the illustration in detail Fig. 5 of the drawings; but the preferable construction is shown in the other

figures and consists in making the bar or shaft sufficiently long to extend a material distance in rear of the pen-point, so as to project into the reservoir and provide a longer feeding-surface, while at the same time causing the ink to drip back into the reservoir quickly when through using the pen and the same is inverted. In all modifications of the feed bar or shaft the same arrangement thereof with reference to the pen-point is preserved. This provides for fitting or arranging the feed bar or shaft within the concavity of the pen-point with its lateral and outer terminal edges in continuous contact therewith to produce capillary attractive channels along the line of such contact.

As may be plainly seen from Figs. 1, 2, and 3 of the drawings, the feed bar or shaft is of such a width as to lie within the concavity of the pen-point and extend longitudinally thereof to a point against the nibs where the ink is drawn out for the tip of the pen-point. This contact of the feed-bar of the pen-point is a close-lying one, so as to leave no air-openings or ink-escape spaces about the edges of the feeder at any point within the pen-point. By reason of the arrangement of the feed bar or shaft 8 longitudinally within the concavity of the pen-point, in contact with the side flanges or wings of the latter, there are provided along the line of contact between the said edges of the feed-bar and the adjacent inner sides of the pen-point the longitudinally-extending lateral ink-flowing channels 9, while the main closed chamber provided between the upper side of the feed-bar and the under side of the pen-point is left open and unobstructed to form an air-passage in communication with the reservoir and providing a direct air-passage for the upward circulation of air as the ink circulates downward along the corners of the chamber where the ink-flowing channels 9 are provided. To secure a reliable flow of the ink and a proper feeding thereof to the nib portion 6 of the pen-point, it is necessary to maintain a close-lying contact between the pen-point and the entire edge portion of the feeder or feed-bar lying therein. This result is preferably attained by forming the feed-bar at its outer or lower end with an upwardly-deflected sealing-terminal 11, which is disposed directly under the nibs or nib portion 6 and is arranged to have its capillary surface closely in contact with such portion and extending transversely across the same, as may be plainly seen from Figs. 1 and 3 of the drawings. This sealing-terminal 11 constitutes a distributing-foot which serves to hold the ink suspended in loop form transversely across the nibs. To render the said foot effective in performing this function, the same is preferably expanded or widened to produce a well-defined capillary surface which contacts with the pen-point beneath the nibs.

The form of the distributing-foot or terminal 11 may be varied somewhat without af-

fecting the results to be accomplished, and a modification thereof is suggested in Figs. 7 and 8 of the drawings. In this suggested modification the feed-bar is formed at its 5 outer or lower end with a tapered convexed lateral offset 11^a, whose rounded surface 12 constitutes the capillary surface of the terminal or foot, which extends transversely across the nib portion of the pen-point, in contact therewith. This rounded capillary surface 12 is of the same form and performs the same function in the shape of feeder shown in Figs. 7 and 8 as it does in the bent type of feed-bar or feeder shown in the group of Figs. 1 to 6, inclusive. By reason of the deflection or offsetting of the distributing-foot or terminal 11 the latter entirely closes in the chamber between the feed-bar and the upper side of the pen-point, and by reason of the rounding form of the capillary surface 12 the latter constitutes a close-lying continuation, transversely across the nibs of the pen, of the capillary channels 9, produced at the longitudinal side edges or surfaces 9^a of the feed-bar. Hence there is no interruption of the continuity of contact between the pen-point and the side and terminal surfaces 9^a and 12 of the feed-bar.

It is also desirable in the carrying out of the invention that provision be made for the entrance of air as nearly as possible at the point where the ink is withdrawn to the paper in the act of writing. This disposition of the air-vent insures against flooding or a precipitous running of the ink, and the desired result is preferably accomplished by providing the feed bar or shaft 8 in the extreme lower end or deflected terminal thereof with an air vent or opening 13. This air vent or opening 13 therefore permits of air entering to replace the withdrawn ink at substantially the point where the ink is withdrawn by the nibs. In this construction the air vent or opening 13 in the feed-bar performs the additional function of an ink-holding loop, which retains superfluous ink as it comes down along the edges of the feed-bar. This loop fills up with the superfluous ink and effectually dams up the air-passage until said superfluous ink is written off. Also the opening or loop 13 is of sufficient size as to compel a complete separation of the streams of ink along the sides of the feeder until the same merge on the distributing-foot transversely beneath the nibs of the pen-point.

Of course the air-feeding idea may be modified—such, for instance, as having the feed-bar entirely imperforate and providing the pen-point itself with an air-vent 14 directly contiguous to the nibs, so as to supply the air at practically the point where the ink is withdrawn by the nibs. Also where no opening or loop at all is provided in either the feed-bar or the pen-point the air will necessarily enter at the lower extremity of

the feed-bar as the nibs are pressed upward in the act of writing. It is at this point that the opening or communication with ink in the reservoir occur, and therefore air must enter there, although the expedient of the perforation or hole 13 in the feed-bar has its practical advantages in providing the ink-holding loop referred to.

In the operation of the pen equipped with a feeder arranged as described the ink is led down to the point of the pen along the corners 9 of the passage 10, while the air ascends the main central part of the said passage. Also by reason of the upward deflection of the outer end of the feed-bar and the continuous contact of its surface 12 the film of ink is drawn and held across the slit in the pen, so as to readily flow from that point.

An improved auxiliary to the feeding means herein described resides in the employment of a flow-regulator, preferably of an adjustable type. This flow-regulator is indicated in dotted lines in Fig. 1 of the drawings and in full lines in Figs. 9, 10, and 11. The said flow-regulator is designated in its entirety by the reference 15, and essentially consists of a substantially straight main shaft-section 16 of any suitable cross-section, preferably rectangular, and provided at one end with a tapered regulating-nose 17, slightly offset to one side of the longitudinal plane of the main shaft-section and whose tapering extremity is adapted to protrude more or less into the inner open end of the feeding channel or chamber 10, provided between the pen 5 and the feed-bar 8. The said tapered regulating-nose 17 is provided at one side with a flat rest-face 18, adapted to rest flat upon the upper side of the feed-bar 8, and at the opposite side has a rounded surface or back 19 curving into the point of the nose and also constituting a wedge portion which assists in holding the regulator in place within the pen-bearing section or nozzle within which it is located. The main shaft-section 16 of the regulator is of sufficient length to extend well into the reservoir to assist in the feeding of the ink out into the main feeder and also draining it back into the reservoir when the pen is inverted after using. To assist these functions, the said shaft-section 16 may also be formed with a channeled feeding side 20, preferably formed in the upper face of the shaft.

The flow-regulator 16 may or may not be used, as desired. It is of special utility, particularly where a large case or reservoir and pen are employed and where it is consequently much more difficult to retain the ink within and along a narrow or contracted tube. By adjusting the nose 17 more or less into the rear end of the feeding channel or chamber 10 the flow of ink can be controlled or regulated, and while various expedients may be resorted to for holding the regulator in position, still, at the same time permitting of ad-

justment thereof, a practical arrangement is shown in the drawings, which involves the holding of the regulator body or section in place, principally by friction, between the regulator and the upper side of the feed-bar and the upper side of the inner surface of the pen-bearing section or nozzle, also possibly by the slight frictional engagement of the point or nose of the regulator within the feeding channel or chamber between the feeder and the pen. It will be obvious that by reason of thus mounting the regulator the same can be moved more or less into the feeding-channel, and hence widen or narrow such channel at the point where it receives its supply from the reservoir, according to the flow desired. The flow-regulator is also useful and desirable as a means to better attract the ink down between the pen and the feeder or at least to better start it down the narrow and comparatively flat channel between the pen and the feeder. By reason of the nose of the regulator projecting a short distance within the open end of the channel between the feed-bar and pen it necessarily serves as a leader and also as a dam or slight obstruction to prevent sudden flow or fall from the reservoir upon the nibs, hence being a check as well as an attracting medium. These functions are subserved irrespective of the adjustability of the regulator. Another function to note in conjunction with the regulator is that on account of the nose thereof lying a short distance within the feeding-channel a slight moisture or film of ink is better retained about the parts and surfaces between the feeder and the pen at that point, so that the interior spaces do not dry off so quickly and the pen starts more readily when first used. Furthermore, the main shaft-section extending back into the reservoir serves to assist in dripping or draining the general body of ink back into the reservoir from the nozzle after using the pen. This function is rendered positive by reason of the main shaft-section of the regulator lying closely against the interior surface of the pen-bearing section at one side thereof.

From the foregoing it is thought that the construction, action, and many advantages of the herein-described improvement will be readily apparent without further description, and it will also be understood that various changes in the form, proportion, and minor details of construction may be resorted to without departing from the spirit of the invention or sacrificing any of the advantages thereof.

Having thus described the invention, what is claimed, and desired to be secured by Letters Patent, is—

1. In a fountain-pen, the combination with the holder carrying the pen-point, of a feed bar or shaft lying within the concavity of the pen with its adjoining lateral and outer terminal surfaces in continuous contact there-

with to provide capillary attractive channels along the line of such contact, and constituting means for holding a loop of ink in suspense across the nibs. 70

2. In a fountain-pen, the combination with the holder carrying the pen-point, of a feed bar or shaft lying within the concavity of the pen with the portion therein having its lateral longitudinal surfaces in close contact therewith, and having its outer terminal surface also in contact with the point transversely of the nibs and directly continuing the contact of the side surfaces to constitute means for holding a loop of ink in suspense across the nibs. 75

3. In a fountain-pen, the combination with the holder carrying the pen-point, of a flat-faced feed bar or shaft lying within the concavity of the point with its adjoining lateral and longitudinal surfaces in continuous contact therewith, and having an outer terminal whose surface contacts with the point transversely of the nibs and directly continues the contact of said lateral surfaces to constitute means for holding a loop of ink in suspense across the nibs. 80

4. In a fountain-pen, the combination with the holder carrying the pen-point, of a flat-faced feed bar or shaft lying within the concavity of the pen-point with the portion therein having its lateral surfaces in continuous contact therewith, and having at its outer end an upwardly-deflected sealing-terminal provided with a curved surface contacting with the point transversely of the nibs and directly continuing the contact of the lateral surfaces. 85

5. In a fountain-pen, the combination with the holder carrying the pen-point, of a feed bar or shaft lying within the concavity of the point with its adjoining lateral and outer terminal surfaces in continuous contact therewith to provide capillary channels along the line of such contact, and means for admitting air contiguous to the outer terminal contact of the feed-bar. 90

6. In a fountain-pen, the combination with the holder carrying the pen-point, of a flat-faced feed bar or shaft held longitudinally within the concavity of the point with the portion therein having its lateral longitudinal surfaces in continuous contact therewith, said feed-bar being provided at its outer end with an upwardly-deflected terminal having a curved surface contacting with the point transversely of the nibs and also having therein an air-vent providing an ink-holding loop. 95

7. In a fountain-pen, the combination with the holder carrying the pen-bearing section, of the pen-point having within the pen-bearing section a holding-plug, and a flat feed bar or shaft interposed between the plug and the pen-point, said feed bar or shaft being held longitudinally within the concavity of the pen-point with the portion therein hav- 100

ing its lateral longitudinal surfaces in continuous contact therewith, and provided at its outer end with an upwardly-deflected sealing-terminal having an air-vent and a rounded surface contacting with the point transversely of the nibs and directly continuing the contact of said lateral surfaces.

8. In a fountain-pen, the combination with the holder carrying the pen-point, of a feeder arranged in spaced relation to the pen to provide an intervening feeding-channel, and a flow-regulator arranged to project into one end of said channel and having a point lying against the feeder.

9. In a fountain-pen, the combination with the holder carrying the pen-point, of a feed-bar arranged in spaced relation to the pen to provide an intervening feeding-channel, and a flow-regulator arranged in the pen-bearing section and having a regulating-nose projecting into the inner open end of said channel and having a point lying against the feeder.

10. In a fountain-pen, the combination with the holder carrying the pen-point, of a feed-bar arranged in spaced relation to the pen to provide an intervening feeding-channel, and an adjustably-mounted flow-regulator located within the pen-bearing section and having a nose projecting into the inner open end of the

feeding-channel, the point of said nose lying against the feed-bar.

11. In a fountain-pen, the combination with the holder carrying the pen-point, of a feed-bar arranged in spaced relation to the pen to provide an intervening feeding-channel, and a flow-regulator held in position within the pen-bearing section between the feed-bar and one side of the pen-bearing section and having a regulating-nose projecting a distance through one end of the channel, the point of said nose lying against the feed-bar.

12. In a fountain-pen, the combination with the holder carrying the pen-point, of a feed-bar arranged in spaced relation to the pen to provide an intervening feeding-channel, and a flow-regulator fitted within the pen-bearing section and consisting of a main shaft-section extending back into the reservoir, and a tapered regulating-nose having a flat side or face resting on the feed-bar and whose point extends a distance into the said channel.

In testimony whereof I affix my signature in presence of two witnesses.

PAUL E. WIRT.

Witnesses:

C. N. FUNSTON,
R. L. ORANGE.